

Gauge Installation:

1. Select the desired mounting location of the instrument.
2. Mount the gauge and secure with the VDO Spin-Lok™ Clamp.
(See page 2 for mounting options and instructions)

Wiring the Gauge (Illustration A):

1. Route wires from the instrument to to:
 - (a) the battery (+) switched power after the fuse box or user supplied in-line fuse – 1 amp
 - (b) the light switch after the fuse box or user supplied in-line fuse -1 amp
 - (c) a good, dedicated ground location.
 - (d) the signal terminals on the sending unit. Changing the supplied extension cable spade connectors at the gauge side and/or soldering to the gauge harness is acceptable.

DO NOT SHORTEN THE EXTENSION CABLE

2. Connect the harness according to the following wiring Matrix:

Pin	Description
1	Red - Battery constant (+12 / 24 V)
2	Black - Ground
3	Blue/Black - Thermocouple Red (Extension Cable White)
4	Brown - Battery switched (+12 / 24 V)
5	Green - Thermocouple Yellow (Extension Cable Blue)
6	Blue/Red - Illumination (+12 / 24 V)
7	Not Connected
8	Not Connected
Note - Use 18 AWG for wire harness	

Merchandise warranted against defects in factory workmanship and materials for a period of 24 months after purchase. This warranty applies to the first retail purchaser and covers only those products exposed to normal use or service. Provisions of this warranty shall not apply to a VDO product used for a purpose for which it is not designed, or which has been altered in any way that would be detrimental to the performance or life of the products, or misapplication, misuse, negligence or accident. On any VDO part or VDO product found to be defective after examination by manufacturer, manufacturer will only repair or replace the merchandise through the original selling dealer. Manufacturer assumes no responsibility for diagnosis, removal and/or installation labor, loss of vehicle use, loss of time, inconvenience or any other consequential expenses. The warranties herein are in lieu of any other expressed or implied warranties, including any implied warranty or merchantability of fitness, and any other obligation on the part of manufacturer, or selling dealer.

Read these instructions thoroughly before installation. Do not deviate from assembly or wiring diagram. Always disconnect battery ground before making any electrical connections.

IMPORTANT: Mounting dimensions vary for different gauges. Please be certain to follow the instructions for your specific gauge.

Parts List		
Item	Description	Qty
1	52mm Gauge	1
2	Spin-Lok™ Clamp	1
3	Gasket	1
4	8 pin Harness	1
5	Thermocouple*	1
6	Extension Cable*	1
7	Instruction Sheet	1

**Items 5 and 6 included in kits only

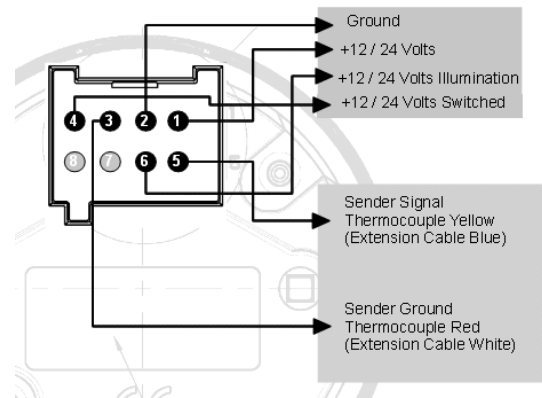

Illustration A

Sensor installation (Illustration B and C):

1. When installing the pyrometer sensor in the exhaust pipe near the elbow flange the maximum depth to the middle of exhaust pipe is 60mm.
2. Mount the bushing centrally and weld on to exhaust pipe. The weld must form a tight seal. Always follow the safety instructions and advise of the welding equipment manufacturer.
3. Connect the ring terminals on the extension cable to the ring terminals on the pyrometer sensor with the supplied screw and nut.
4. Route the extension cable to gauge location. Keep away from high temperature locations and moving parts.

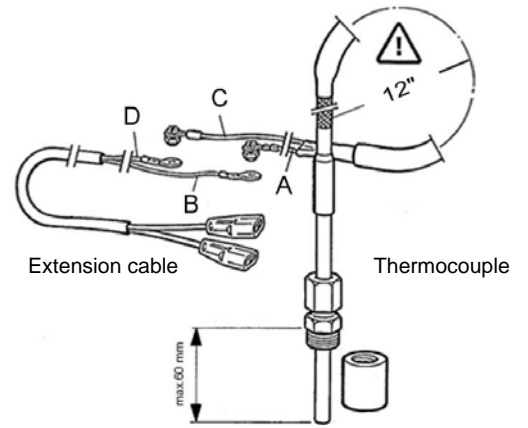

Illustration B

Wire	Color
A	Red
to	
B	White
to	
C	Yellow
to	
D	Blue

Use the above table and Illustration B to match and assemble the extension cable to pyrometer sensor.

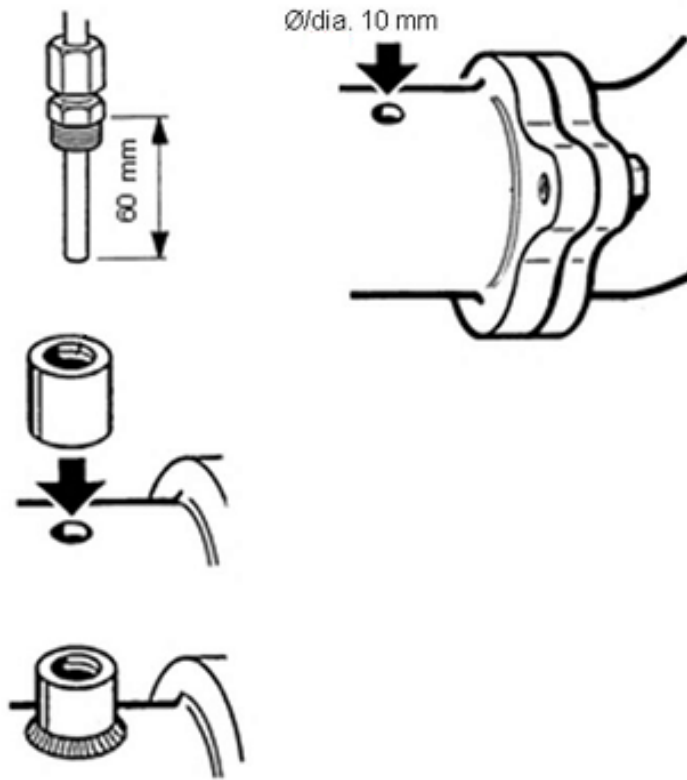

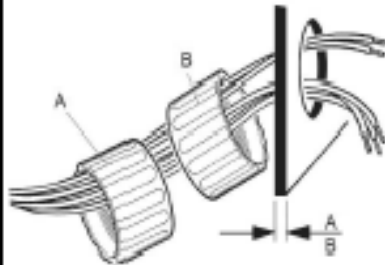
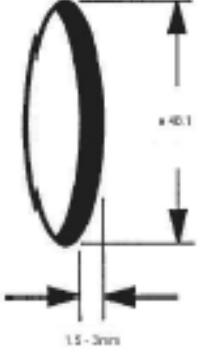
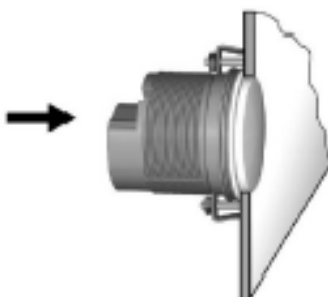





Illustration C

52mm		
Conventional (Included)	Flush (Optional)	Stud (Optional)
<p>Instrument is put into the drilled hole from the front. The maximum panel thickness is 20mm. The drilled hole must have a diameter of 53mm.</p>  <p>* Make sure the seal lays flat between the panel and the front ring.</p> <p>For 52mm instruments, the Spin-Lok™ nut can be mounted at position A or B. This allows you two clamping depths.</p>  <p>Version A 10mm</p> <p>Version B 20mm</p>	<p>When flush mounting (i. e., from the back so that the instrument glass and the panel form one plane), the front ring must be removed. Press on the instrument glass with both thumbs, while at the same time pulling the front ring forward from the instrument with both index fingers.</p>  <p>The recommended panel thickness is 1.5 to 3 mm. The drill hole must have a diameter of 48.1mm. Ensure that the installation location is level and has no sharp edges.</p>  <p>Place the flush mount seal on the instrument glass. Put the instrument into the drill hole from the back. Adjust the instrument so that the gauge is level and fasten it to the stud bolts (not included) on the rear side of the panel, using the flush mount fixing brackets.</p>	<p>If you would like to omit the fastening nut, you may use the stud mount as an alternative. This is recommended if the installation location is subject to extreme vibrations. Screw the stud bolts into the drilled holes on the rear of the instrument housing. Max. stud bolt torque is 1.5Nm.</p>  <p>Place the bracket on the stud bolt and tighten the knurled nut. Do not over-tighten.</p>   <p>* Make sure the seal lays flat between the panel and the front ring.</p>