

Make point switch A2C59510886	TU00-0752-6507101	02/14	1-3	1

Safety information



- The product was developed, manufactured and inspected according to the basic safety requirements of EC Guidelines and state-of-the-art technology.
- The unit is designed for use in grounded vehicles and machines as well as in nautical sports, including non-classified commercial shipping.
- Use our product only as intended. Use of the product for reasons other than its intended use may lead to personal injury, property damage or environmental damage. Before installation, check the vehicle documentation for vehicle type and any possible special features!
- Use the assembly plan to learn the location of the fuel/hydraulic/ compressed air and electrical lines!
- Note possible modification to the vehicle, which must be considered during installation!
- To prevent personal injury, property damage or environmental damage, basic knowledge of motor vehicle/shipbuilding electronics and mechanics is required.
- Make sure that the engine cannot start unintentionally during installation!
- Modifications or manipulations to the VDO product can affect safety. Consequently, you may not modify or manipulate the product!
- When removing/installing seats, covers, etc., ensure that lines are not damaged and plug-in connections are not loosened!
- Note all data from other installed units with volatile electronic

Safety during installation:

- During installation, ensure that the product's components do not affect or limit vehicle functions. Avoid damaging these components!
- Only install undamaged parts in a vehicle!
- During installation, ensure that the product does not impair the field of vision and that it cannot impact the driver's or passenger's head!
- A specialized technician should install the product. If you install the product yourself, wear appropriate work clothing. Do not wear loose clothing, as it may get caught in moving parts. Protect long hair with a hair net.
- When working on the on-board electronics, do not wear metallic or conductive jewelry such as necklaces, bracelets, rings, etc.
- If work on a running engine is required, exercise extreme caution. Wear only appropriate work clothing as you are at risk of personal injury resulting from being crushed or burned.
- Before taking any action, disconnect the negative terminal on the battery, otherwise you risk a short circuit. If the vehicle is supplied by auxiliary batteries, you must also disconnect the negative terminals on these batteries! Short circuits can cause fires, battery explosions and damages to other electronic systems. Please note that when you disconnect the battery, all volatile electronic memory lose their input values and must be reprogrammed.
- If working on gasoline boat motors, let the motor compartment fan run before beginning work.
- Pay attention to how lines and cable harnesses are laid so that you do not drill or saw through them!
- Do not choose to install the product in the mechanical and electrical airbag area!
- Do not drill holes or ports in load-bearing or stabilizing stays or tie bars!
- When working underneath the vehicle, secure it according to the specifications from the vehicle manufacturer.
- Note the necessary clearance behind the drill hole or port at the installation location. Required mounting depth: 65 mm.
- Drill small ports; enlarge and complete them, if necessary using taper milling tools, saber saw, keyhole saw or file. Deburr edges. Follow the safety instructions of the tool manufacturer.
- Use only insulated tools if work is necessary on live parts.
- Use only the multimeter or diode test lamps provided to measure voltages and currents in the vehicle/machine or ship. Use of conventional test lamps can cause damage to control units or other electronic systems.

No smoking! No open fire or lights!

- The electrical indicator outputs and cables connected to them must be protected from direct contact and damage. The cables in use must have sufficient insulation and electric strength, and the contact points must be safe from touch.
- Use appropriate measures to also protect the electrically conductive parts on the connected consumer from direct contact. Laying metallic, uninsulated cables and contacts is prohibited.

Safety after installation:

- Connect the ground cable tightly to the negative terminal of the battery.
- Reenter/reprogram the volatile electronic memory values.
- Check all functions.
- Use only clean water to clean the components. Note the Ingress Protection (IP) ratings (IEC 60529).

Electrical connection:

- Note cable cross-sectional area!
- Reducing the cable cross-sectional area leads to higher current density, which can cause the cable cross-sectional area in question to heat up!
- When installing electrical cable, use the provided cable ducts and harnesses, however, do not run cables parallel to ignition cables or to cables that lead to large electricity consumers.
- Fasten cables with cable ties or adhesive tape. Do not run cables over moving parts. Do not attach cables to the steering column!
- Ensure that cables are not subject to tensile, compressive or shearing forces.
- If cables are run through drill holes, protect them using rubber sleeves or the like.
- Use only one cable stripper to strip the cable. Adjust the stripper so that stranded wires are not damaged or separated.
- Only use a soft soldering process or commercially available crimp connector to solder new cable connections!
- Only make crimp connections with cable crimping pliers. Follow the safety instructions of the tool manufacturer.
- Insulate exposed stranded wires to prevent short circuits.
- Caution: Risk of short circuit if junctions are faulty or cables are damaged.
- Short circuits in the vehicle network can cause fires, battery explosions and damages to other electronic systems. Consequently, all power supply cable connections must be provided with weldable connectors and be sufficiently insulated.
- Ensure ground connections are sound.
- Faulty connections can cause short circuits. Only connect cables according to the electrical wiring diagram.
- If operating the instrument on power supply units, note that the power supply unit must be stabilized, and it must comply with the following standard: DIN EN 61000, Parts 6-1 to 6-4.

Make point switch A2C59510886	TU00-0752-6507101	02/14	1-3	2

Procedures for installing VDO Viewline instruments

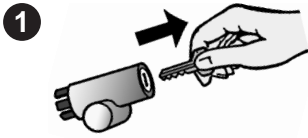

Before beginning, turn off the ignition and remove the ignition key. If necessary, remove the main circuit switch.

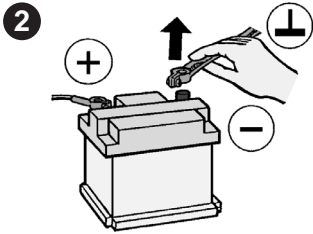

Disconnect the negative terminal on the battery. Make sure the battery cannot unintentionally restart.

- Before taking any action, disconnect the negative terminal on the battery, otherwise you risk a short circuit. If the vehicle is supplied by auxiliary batteries, you must also disconnect the negative terminals on these batteries! Short circuits can cause fires, battery explosions and damages to other electronic systems. Please note that when you disconnect the battery all volatile electronic memory lose their input values and must be reprogrammed.

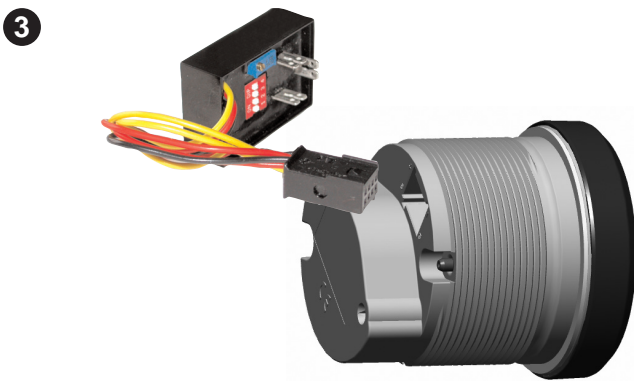

Insert the warning point control connector into the indicator

Connect blue/red illumination wire to a switched 12 volt power source for gauge illumination

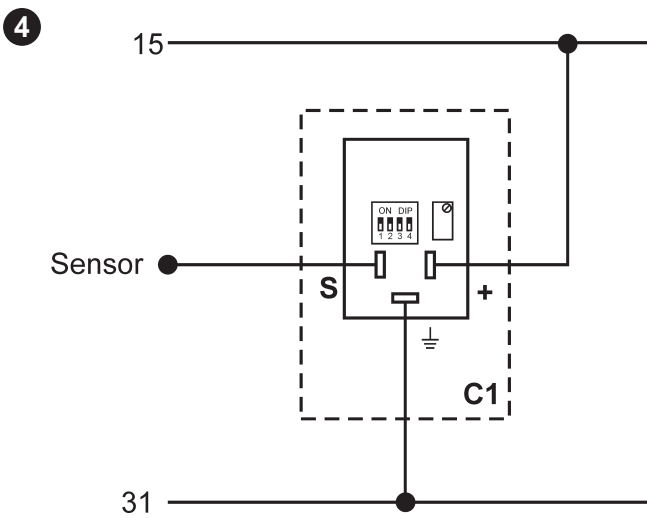

Switch positions:

- 1 ON, 2 OFF: Indicator light ON at rising* sensor resistances
- 1 OFF, 2 ON: Indicator light ON at falling* sensor resistances
- 3 ON, 4 OFF: Normal operation
- 3 OFF, 4 ON: Warning point setting

Designations in the wiring diagram:

15 - terminal 15 - connected plus 12V – 32V

31 - terminal 31 - ground

C1 - warning point control (switching capacity = 300 mA, not short circuit proof)

You must comply with the wiring diagram.

Sensor - pressure, temperature and supply sensor from the VDO Standard Program

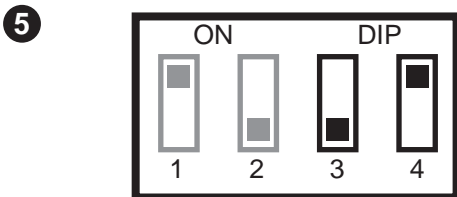

Setting the warning point:

For the warning point setting, set switch 3 to OFF and switch 4 to ON.

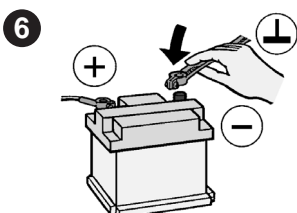

Reconnect the battery after inspecting the connection.



- Please note that when you disconnect the battery, all volatile electronic memory lose their input values and must be reprogrammed.

Make point switch A2C59510886	TU00-0752-6507101	02/14	1-3	3

7

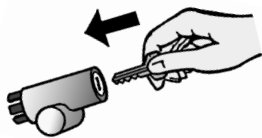

If necessary, replace the main circuit switch. Turn on the ignition and conduct a functional test.
Reprogram other instruments that may have lost their saved settings.

8

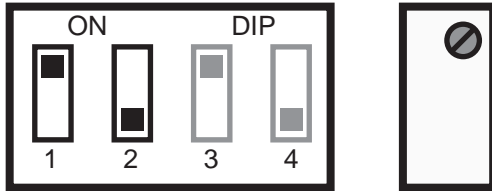

Select the warning range:
For the warning at rising sensor resistance, set switch 1 to ON and switch 2 to OFF.

Turn the potentiometer until the indicator is at the position at which the warning light should be activated. (The warning light will not activate based on the position of the indicator while setting the potentiometer.)



Examples:
Supply sensor with submerged supply sensor, warning when level too low (fuel).
Temperature indicator, warning when temperature too low (oil / water).
Pressure indicator, warning when pressure too high (oil).

9

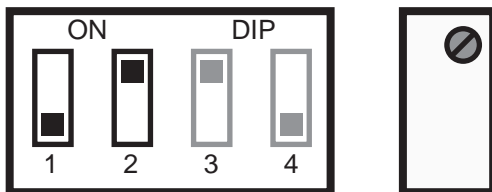

Select the warning range:
For the warning at falling sensor resistance, set switch 1 to OFF and switch 2 to ON.

Turn the potentiometer until the indicator is at the position at which the warning light should be activated. (The warning light will not activate based on the position of the indicator while setting the potentiometer.)



Examples:
Pressure indicator, warning when pressure too low (oil).
Supply sensor with lever supply sensor, warning when level too low (fuel).



Example:
Temperature indicator, warning when temperature too high (oil / water).

10

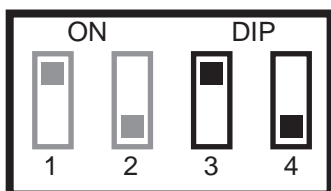

For normal operation, set switch 3 to ON and switch 4 to OFF.